

## LM337L

### 3-Terminal Adjustable Regulator

#### General Description

The LM337L is an adjustable 3-terminal negative voltage regulator capable of supplying 100mA over a 1.2V to 37V output range. It is exceptionally easy to use and requires only two external resistors to set the output voltage. Furthermore, both line and load regulation are better than standard fixed regulators. Also, the LM337L is packaged in a standard TO-92 transistor package which is easy to use.

In addition to higher performance than fixed regulators, the LM337L offers full overload protection. Included on the chip are current limit, thermal overload protection and safe area protection. All overload protection circuitry remains fully functional even if the adjustment terminal is disconnected.

Normally, only a single 1 $\mu$ F solid tantalum output capacitor is needed unless the device is situated more than 6 inches from the input filter capacitors, in which case an input bypass is needed. A larger output capacitor can be added to improve transient response. The adjustment terminal can be bypassed to achieve very high ripple rejection ratios which are difficult to achieve with standard 3-terminal regulators.

Besides replacing fixed regulators, the LM337L is useful in a wide variety of other applications. Since the regulator is "floating" and sees only the input-to-output differential voltage, supplies of several hundred volts can be regulated as long as the maximum input-to-output differential is not exceeded.

Also, it makes an especially simple adjustable switching regulator, a programmable output regulator, or by connecting

a fixed resistor between the adjustment and output, the LM337L can be used as a precision current regulator. Supplies with electronic shutdown can be achieved by clamping the adjustment terminal to ground which programs the output to 1.2V where most loads draw little current.

The LM337L is available in a standard TO-92 transistor package, SO-8 surface mount package, and in our new 12 mil diameter bump micro SMD package. The LM337L is rated for operation over a  $-25^{\circ}\text{C}$  to  $+125^{\circ}\text{C}$  range.

For applications requiring greater output current in excess of 0.5A and 1.5A, see LM137 series data sheets. For the positive complement, see series LM117 and LM317L data sheets.

#### Features

- Adjustable output down to 1.2V
- Guaranteed 100mA output current
- Line regulation typically 0.01%/V
- Load regulation typically 0.1%
- Current limit constant with temperature
- Eliminates the need to stock many voltages
- Standard 3-lead transistor package
- 80 dB ripple rejection
- Output is short circuit protected
- Available in the 6-Bump micro SMD package
- See AN-1112 for micro SMD considerations

#### Typical Application

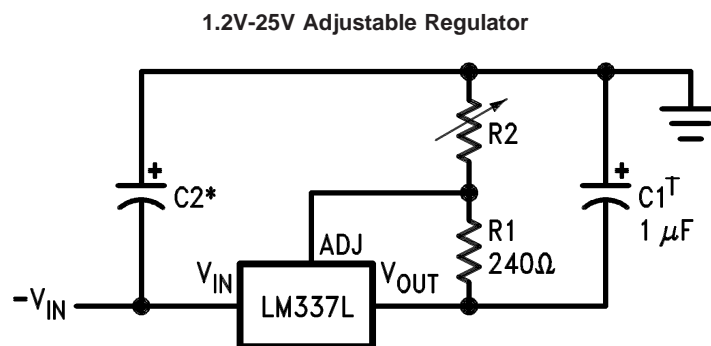

## Connection Diagrams

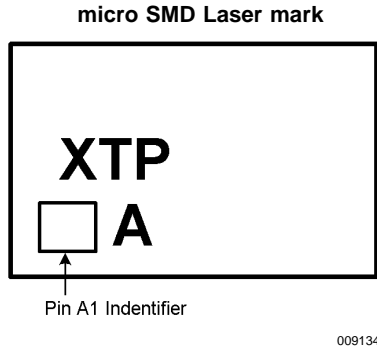
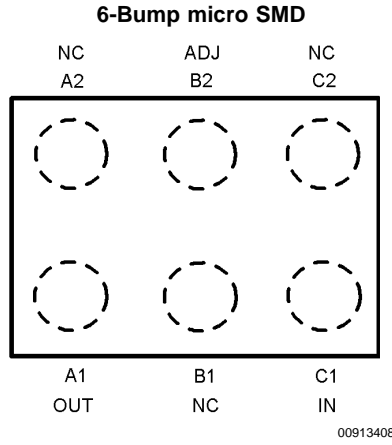
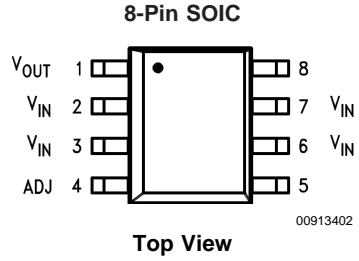
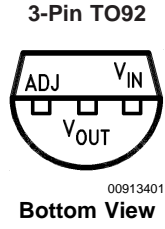

## Ordering Information

Package	Part Number	Package Marking	Transport Media	NSC Drawing
3-Pin TO92	LM337LZ	LM337LZ	1800 per Bag	Z03A
8-Pin SOIC	LM337LM	LM337LM	Rails	M08A
	LM337LMX		2.5k Units Tape and Reel	
6-Bump micro SMD	LM337LBL	PA	250 Units Tape and Reel	BLA06FNB
	LM337LBLX		3k Units Tape and Reel	

**Absolute Maximum Ratings** (Note 1)

If Military/Aerospace specified devices are required, please contact the National Semiconductor Sales Office/Distributors for availability and specifications.

Power Dissipation	Internally Limited
Input–Output Voltage Differential	40V
Operating Junction Temperature Range	–25°C to +125°C

Storage Temperature	–55°C to +150°C
Lead Temperature (Soldering, 10 sec.)	300°C
Plastic Package (Soldering 4 sec.)	260°C
ESD Rating	1.5kV (Note 5)

**Electrical Characteristics** (Note 2)

Parameter	Conditions	Min	Typ	Max	Units
Line Regulation	$T_A = 25^\circ\text{C}$ , $3\text{V} \leq  V_{\text{IN}} - V_{\text{OUT}}  \leq 40\text{V}$ , (Note 3)		0.01	0.04	%/V
Load Regulation	$T_A = 25^\circ\text{C}$ , $5\text{mA} \leq I_{\text{OUT}} \leq I_{\text{MAX}}$ , (Note 3)		0.1	0.5	%
Thermal Regulation	$T_A = 25^\circ\text{C}$ , 10ms Pulse		0.04	0.2	%/W
Adjustment Pin Current			50	100	$\mu\text{A}$
Adjustment Pin Current Change	$5\text{mA} \leq I_L \leq 100\text{mA}$ $3\text{V} \leq  V_{\text{IN}} - V_{\text{OUT}}  \leq 40\text{V}$		0.2	5	$\mu\text{A}$
Reference Voltage	$3\text{V} \leq  V_{\text{IN}} - V_{\text{OUT}}  \leq 40\text{V}$ , (Note 4) $10\text{mA} \leq I_{\text{OUT}} \leq 100\text{mA}$ , $P \leq 625\text{mW}$	1.20	1.25	1.30	V
Line Regulation	$3\text{V} \leq  V_{\text{IN}} - V_{\text{OUT}}  \leq 40\text{V}$ , (Note 3)		0.02	0.07	%/V
Load Regulation	$5\text{mA} \leq I_{\text{OUT}} \leq 100\text{mA}$ , (Note 3)		0.3	1.5	%
Temperature Stability	$T_{\text{MIN}} \leq T_J \leq T_{\text{MAX}}$		0.65		%
Minimum Load Current	$ V_{\text{IN}} - V_{\text{OUT}}  \leq 40\text{V}$ $3\text{V} \leq  V_{\text{IN}} - V_{\text{OUT}}  \leq 15\text{V}$		3.5 2.2	5 3.5	 mA mA
Current Limit	$3\text{V} \leq  V_{\text{IN}} - V_{\text{OUT}}  \leq 13\text{V}$ $ V_{\text{IN}} - V_{\text{OUT}}  = 40\text{V}$	100 25	200 50	320 120	 mA mA
Rms Output Noise, % of $V_{\text{OUT}}$	$T_A = 25^\circ\text{C}$ , $10\text{Hz} \leq f \leq 10\text{kHz}$		0.003		%
Ripple Rejection Ratio	$V_{\text{OUT}} = -10\text{V}$ , $F = 120\text{Hz}$ , $C_{\text{ADJ}} = 0$ $C_{\text{ADJ}} = 10\mu\text{F}$	66	65 80		 dB dB
Long-Term Stability	$T_A = 125^\circ\text{C}$		0.3	1	%

**Note 1:** "Absolute Maximum Ratings" indicate limits beyond which damage to the device may occur. Operating Ratings indicate conditions for which the device is functional, but do not guarantee specific performance limits.

**Note 2:** Unless otherwise specified, these specifications apply  $-25^\circ\text{C} \leq T_J \leq +125^\circ\text{C}$  for the LM337L;  $|V_{\text{IN}} - V_{\text{OUT}}| = 5\text{V}$  and  $I_{\text{OUT}} = 40\text{mA}$ . Although power dissipation is internally limited, these specifications are applicable for power dissipations up to 625 mW.  $I_{\text{MAX}}$  is 100mA.

**Note 3:** Regulation is measured at constant junction temperature, using pulse testing with a low duty cycle. Changes in output voltage due to heating effects are covered under the specification for thermal regulation.

**Note 4:** Thermal resistance of the TO-92 package is  $180^\circ\text{C/W}$  junction to ambient with 0.4" leads from a PC board and  $160^\circ\text{C/W}$  junction to ambient with 0.125" lead length to PC board. The M package  $\theta_{\text{JA}}$  is  $180^\circ\text{C/W}$  in still air. The 6-Bump micro SMD package  $\theta_{\text{JA}}$  is  $290^\circ\text{C/W}$  in still air.

**Note 5:** Human body model,  $1.5\text{k}\Omega$  in series with  $100\text{pF}$ .

## Typical Applications

### 1.2V-25V Adjustable Regulator

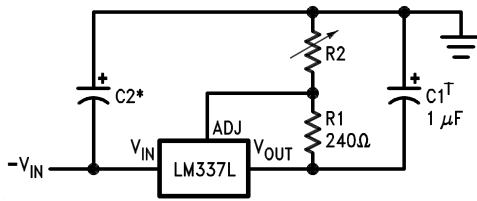

00913403

Full output current not available at high input-output voltages

$$-V_{OUT} = -1.25V \left( 1 + \frac{R2}{240\Omega} \right)$$

†C1 = 1 μF solid tantalum or 10 μF aluminum electrolytic required for stability

\*C2 = 1 μF solid tantalum is required only if regulator is more than 4" from power supply filter capacitor

### Regulator with Trimmable Output Voltage

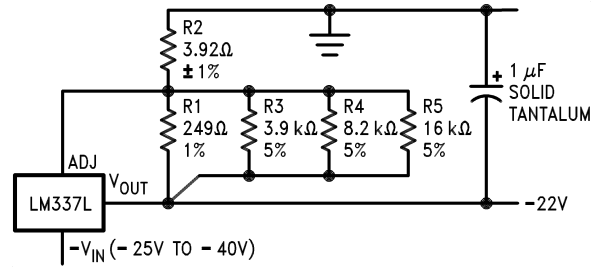

00913404

Trim Procedure:

- If  $V_{OUT}$  is  $-23.08V$  or bigger, cut out R3 (if smaller, don't cut it out).
- Then if  $V_{OUT}$  is  $-22.47V$  or bigger, cut out R4 (if smaller, don't).
- Then if  $V_{OUT}$  is  $-22.16V$  or bigger, cut out R5 (if smaller, don't).

This will trim the output to well within 1% of  $-22.00 V_{DC}$ , without any of the expense or trouble of a trim pot (see LB-46). Of course, this technique can be used at any output voltage level.

**Physical Dimensions** inches (millimeters)

unless otherwise noted

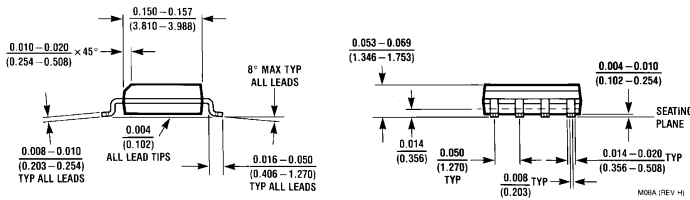
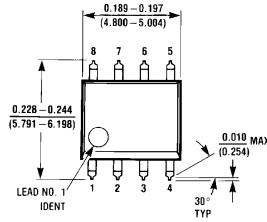

**8-Pin SOIC**  
NS Package Number M08A

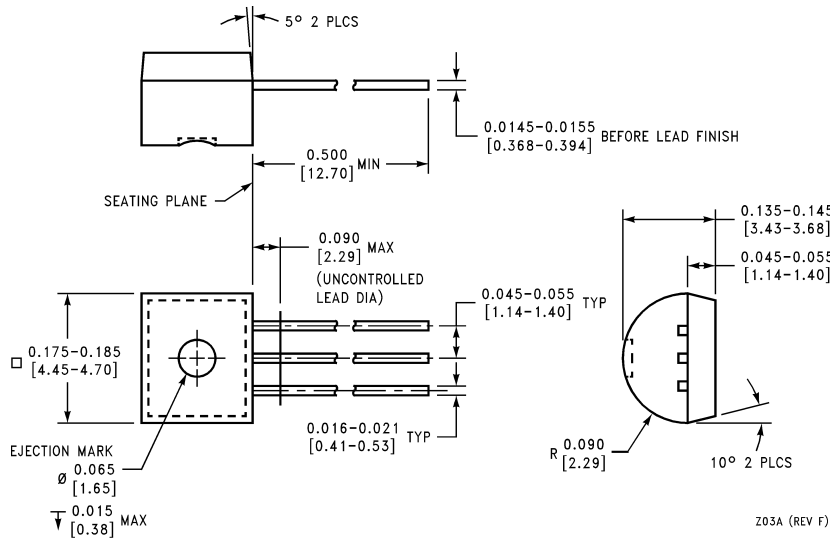

**3-Pin TO-92 (Z)**  
NS Package Number Z03A

**Physical Dimensions** inches (millimeters) unless otherwise noted (Continued)

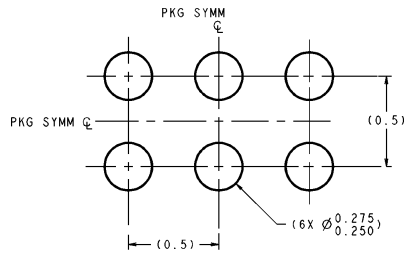

**LAND PATTERN RECOMMENDATION**

**DIMENSIONS ARE IN MILLIMETERS**

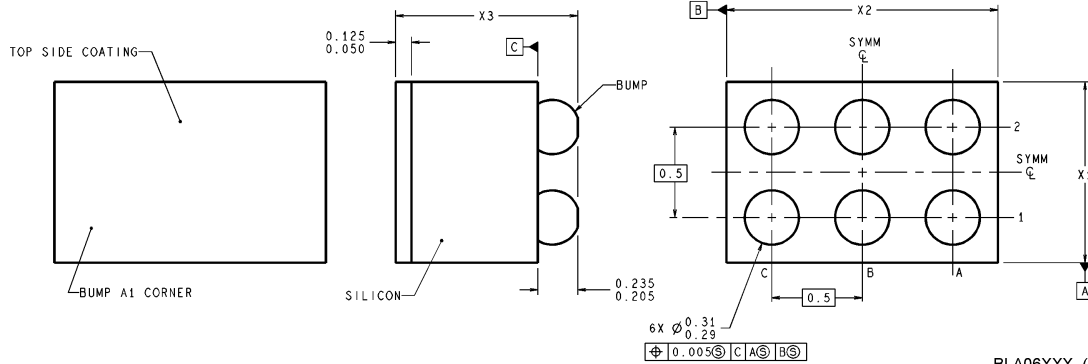

BLA06XXX (Rev B)

**6-Bump micro SMD**  
**NS Package Number BLA06FNB**  
**X1 = 1133µm X2 = 1819µm X3 = 945µm**

NOTES: UNLESS OTHERWISE SPECIFIED

1. EPOXY COATING.
2. 63Sn/37Pb EUTECTIC BUMP.
3. RECOMMEND NON-SOLDER MASK DEFINED LANDING PAD.
4. PIN A1 IS ESTABLISHED BY LOWER LEFT CORNER WITH RESPECT TO TEXT ORIENTATION. REMAINING PINS ARE NUMBERED COUNTERCLOCKWISE.
5. XXX IN DRAWING NUMBER REPRESENTS PACKAGE SIZE VARIATION WHERE X1 IS PACKAGE WIDTH, X2 IS PACKAGE LENGTH AND X3 IS PACKAGE HEIGHT (SEE TABLE, SHEET 2). EXAMPLE: BLA06AFA HAS WIDTH = 1006. LENGTH = 1641, HEIGHT = 795.
6. REFERENCE JEDEC REGISTRATION MO-211, VARIATION BC.

**LIFE SUPPORT POLICY**

NATIONAL'S PRODUCTS ARE NOT AUTHORIZED FOR USE AS CRITICAL COMPONENTS IN LIFE SUPPORT DEVICES OR SYSTEMS WITHOUT THE EXPRESS WRITTEN APPROVAL OF THE PRESIDENT AND GENERAL COUNSEL OF NATIONAL SEMICONDUCTOR CORPORATION. As used herein:

1. Life support devices or systems are devices or systems which, (a) are intended for surgical implant into the body, or (b) support or sustain life, and whose failure to perform when properly used in accordance with instructions for use provided in the labeling, can be reasonably expected to result in a significant injury to the user.
2. A critical component is any component of a life support device or system whose failure to perform can be reasonably expected to cause the failure of the life support device or system, or to affect its safety or effectiveness.

 **National Semiconductor Corporation**  
Americas  
Email: support@nsc.com

www.national.com

**National Semiconductor Europe**  
Fax: +49 (0) 180-530 85 86  
Email: europe.support@nsc.com  
Deutsch Tel: +49 (0) 69 9508 6208  
English Tel: +44 (0) 870 24 0 2171  
Français Tel: +33 (0) 1 41 91 8790

**National Semiconductor Asia Pacific Customer Response Group**  
Tel: 65-2544466  
Fax: 65-2504466  
Email: ap.support@nsc.com

**National Semiconductor Japan Ltd.**  
Tel: 81-3-5639-7560  
Fax: 81-3-5639-7507

This datasheet has been download from:

[www.datasheetcatalog.com](http://www.datasheetcatalog.com)

Datasheets for electronics components.